

UL
E301099

SÉRIE 8500 FEUILLE D'INSTALLATION 8500 SERIES INSTALLATION SHEET

1. Installation

1. Appuyer et coller le ruban DEL (suivre les guides 10 mm) sur le rail.

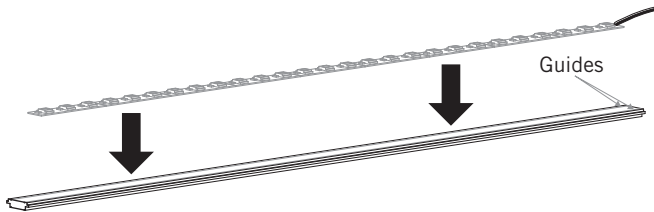

2. Glisser le rail à l'intérieur de la barre profilée.

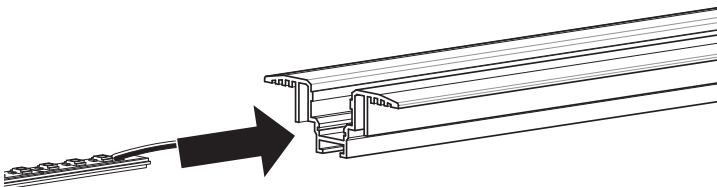

Safe, Fast and Easy to install with the EZLED POWER
Installation simple et rapide avec le système de connexion
EZLED POWER



- Utiliser seulement des composantes Certifiées Classe 2 n'excédant pas 30 VCC ou 15VAC lors d'une installation dans un endroit mouillé ou 60VCC ou 42,4V ca maximum lors d'une installation dans un endroit sec ou humide.
- Ne pas dépasser 5 ampères pour respecter les normes classe 2.
- Use only Class 2 rated components not exceeding 30VDC or 15VAC when installing the outline lighting in wet locations or 60VDC or 42,4V peak ac when installing the outline lighting in a dry or damp location.
- Do not go over 5 amps to match class 2 requirements.

Mise en garde / Warning

1. Installation

1. Press and glue the LED Strip Tape onto the rail (follow 10 mm guides).

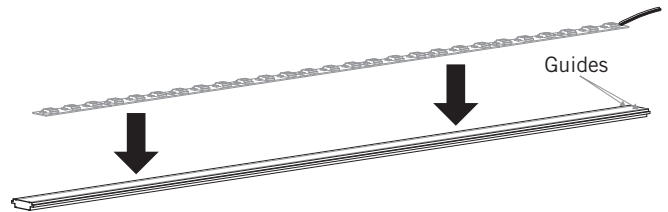

2. Slide the rail into the profiled bar.

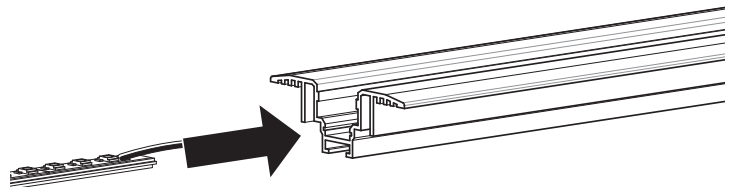

1. Installation

3a. Installation avec lentille: mettre la lentille en place.

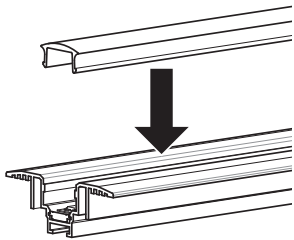

3b. Installation avec diffuseur en acrylique: glisser le diffuseur à l'intérieur de la barre profilée.

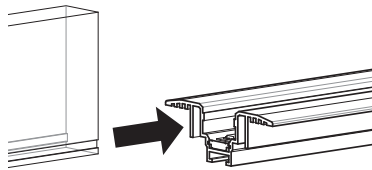

4. Glisser les embouts en place.

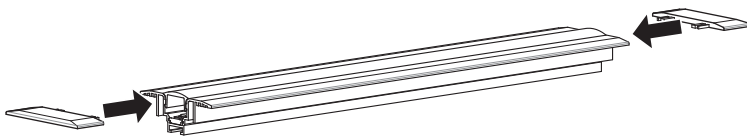

5. Glisser les fixations d'attache à ressort sur la barre profilée en alignant les trous des vis de fixation. Reserrer les vis.

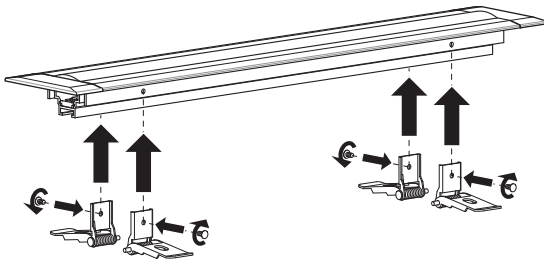

6. Rabattre les bras des fixations en insérant le luminaire dans le trou du mur ou plafond, jusqu'au ras de la surface. Les ressorts vont fixer le luminaire en place.

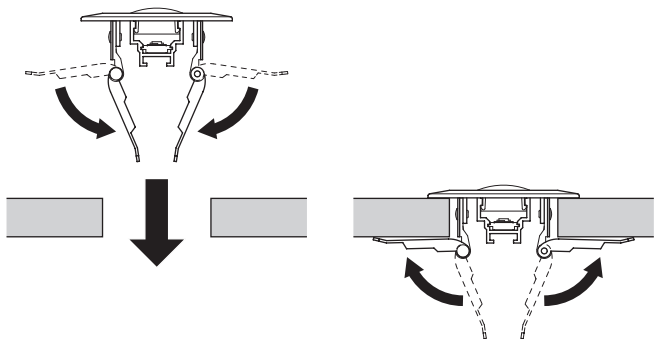

1. Installation

3a. Installation with lens: clip the lens into place.

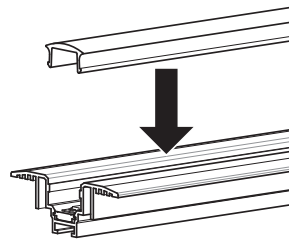

3b. Installation with acrylic diffuser: Slide the diffuser into the profiled bar.

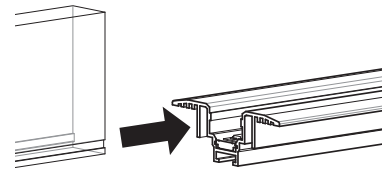

4. Slide the encaps into place.

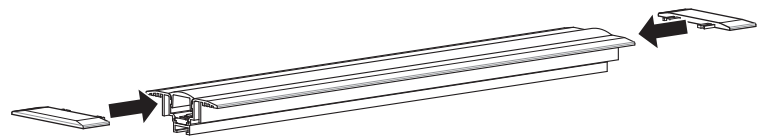

5. Slide the spring toggle mounting brackets onto the profiled bar, aligning bolt holes. Tighten the bolts.

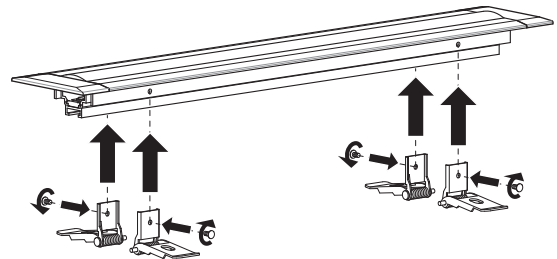

6. Tilt in the bracket arms and pass the lighting fixture through the hole in the wall or ceiling, until flush with surface. The springs will release the arms to secure the fixture in place.

